

# INSTALLATION INSTRUCTION ODEON LIGHT COLLECTION NATURE 4048/1W

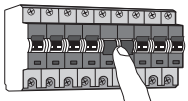

**OFF**

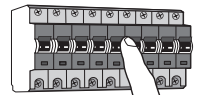
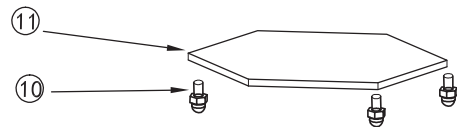
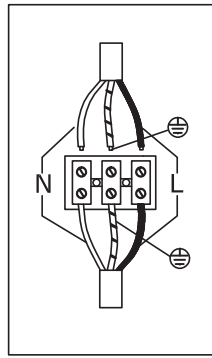
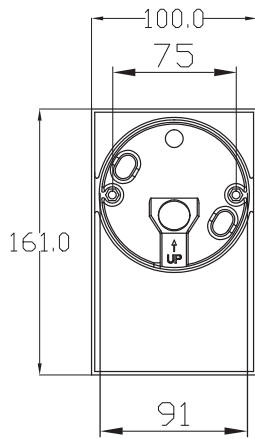
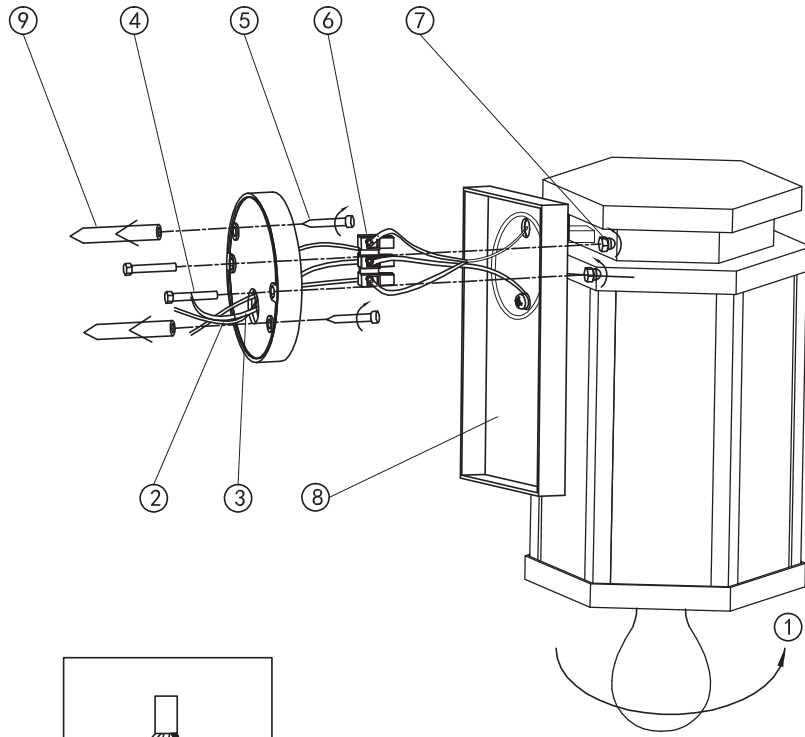
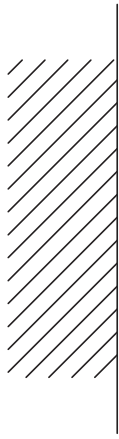

**ON**

