

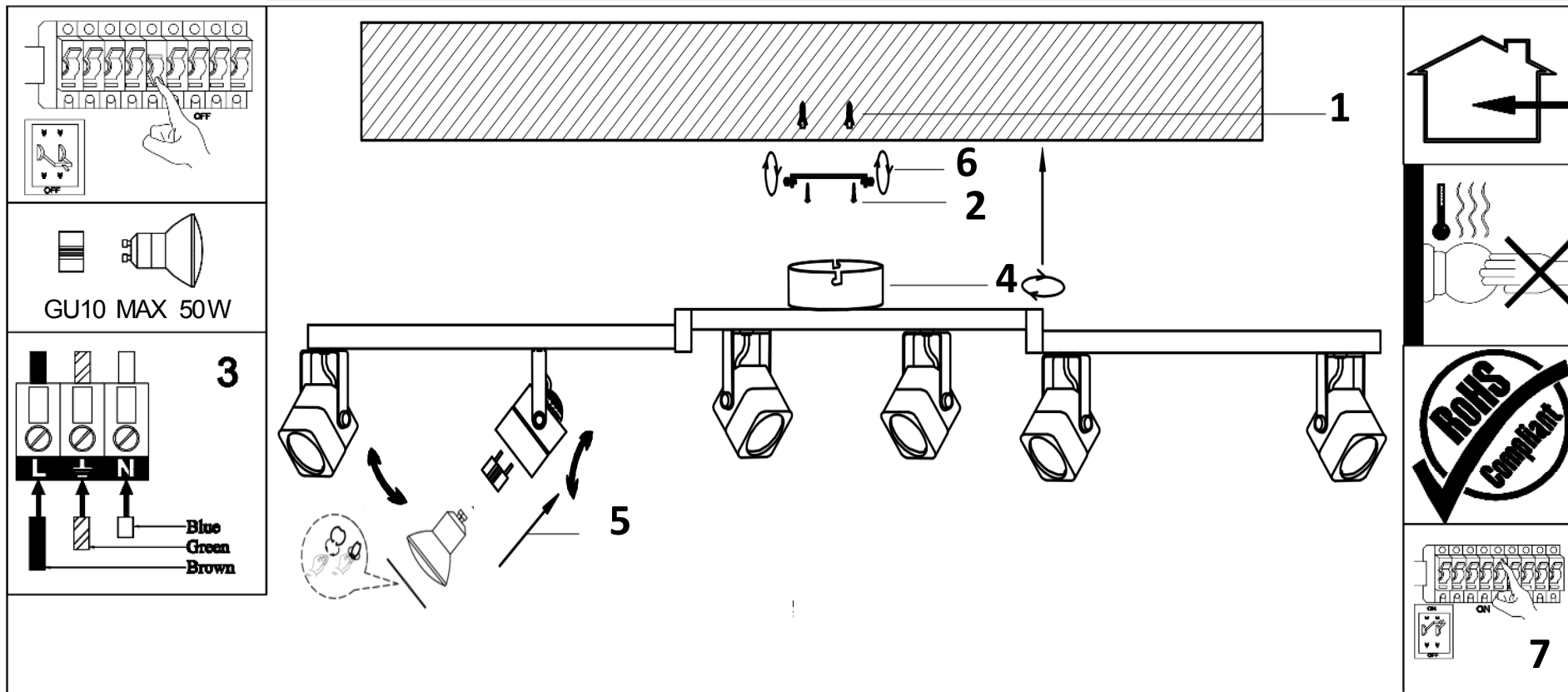

ASSEMBLY INSTRUCTION / ІНСТРУКЦІЯ

A1314PL-6



Installation instruction for this item:

1.Remove the cover and put the lamp on a clean place, then install the lamp; 2.The lamp is limited to used 50W bulb;

Warning:

- 1.Turn off the main power at the circuit breaker before installing the lamp in order to prevent possible shock;
- 2.Please wear gloves when installing the lamp;
- 3.Don't exceed the rated voltage 230V ;
- 4.Don't install on haven't finished ceiling and loose wood ceiling;
- 5.Do not use corrosive liquids to clean fixture such as acid,and alkaline liquids. Please use soft cloth when cleaning.